



# pH 7110

pH METER



a xylem brand

**Copyright** © 2017 Xylem Analytics Germany GmbH  
Printed in Germany.

## pH 7110 - Contents

<b>1</b>	<b>Overview</b> .....	<b>7</b>
1.1	pH 7110 meter.....	7
1.2	Sensors .....	7
<b>2</b>	<b>Safety</b> .....	<b>8</b>
2.1	Safety information .....	8
2.1.1	Safety information in the operating manual.....	8
2.1.2	Safety signs on the meter .....	8
2.1.3	Further documents providing safety information.....	8
2.2	Safe operation .....	9
2.2.1	Authorized use .....	9
2.2.2	Requirements for safe operation.....	9
2.2.3	Unauthorized use .....	9
<b>3</b>	<b>Commissioning</b> .....	<b>10</b>
3.1	Scope of delivery.....	10
3.2	Power supply.....	10
3.3	Initial commissioning .....	10
3.3.1	Inserting the batteries .....	10
3.3.2	Connecting the power pack.....	11
3.3.3	Mounting the stand .....	12
<b>4</b>	<b>Operation</b> .....	<b>13</b>
4.1	General operating principles .....	13
4.1.1	Keypad .....	13
4.1.2	Display .....	14

---

4.1.3	Status information .....	14
4.1.4	Socket field .....	15
4.2	Switching on the meter.....	15
4.3	Switching off the meter.....	15
4.4	Navigation .....	16
4.4.1	Operating modes .....	16
4.4.2	Measuring mode (measured value display).....	16
4.4.3	Setting mode .....	16
<b>5</b>	<b>pH value .....</b>	<b>17</b>
5.1	Measuring.....	17
5.1.1	Measuring the pH value.....	17
5.1.2	Measuring the temperature .....	18
5.2	Calibration .....	18
5.2.1	Why calibrate?.....	18
5.2.2	When to calibrate?.....	19
5.2.3	Automatic calibration (AutoCal) .....	19
5.2.4	Manual calibration (ConCal) .....	21
5.2.5	Calibration points .....	23
5.2.6	Calibration data .....	23
<b>6</b>	<b>ORP .....</b>	<b>26</b>
6.1	Measuring.....	26
6.1.1	Measuring the ORP .....	26
6.1.2	Measuring the temperature .....	27
6.2	Calibration .....	27
<b>7</b>	<b>Settings .....</b>	<b>28</b>
7.1	Measurement settings (pH) .....	28
7.1.1	Changing the settings for pH measurements.....	28
7.1.2	Buffer sets for calibration .....	29
7.1.3	Calibration interval.....	30
7.2	Measurement settings (ORP).....	30
7.2.1	Changing the settings for ORP measurements .....	30

---

7.3	Sensor-independent settings . . . . .	31
7.3.1	Changing the sensor-independent settings . . . . .	31
7.3.2	Energy saving (battery operation) . . . . .	31
<b>8</b>	<b>Reset . . . . .</b>	<b>32</b>
8.1	Resetting the calibration values . . . . .	32
8.2	Resetting the measurement and system settings . . . . .	32
<b>9</b>	<b>Maintenance, cleaning, disposal . . . . .</b>	<b>34</b>
9.1	Maintenance . . . . .	34
9.1.1	General maintenance activities . . . . .	34
9.1.2	Replacing the batteries . . . . .	34
9.2	Cleaning . . . . .	35
9.3	Packing . . . . .	35
9.4	Disposal . . . . .	35
<b>10</b>	<b>What to do if... . . . . .</b>	<b>36</b>
10.1	pH . . . . .	36
10.1.1	No stable measured value . . . . .	36
10.1.2	Error message CalError . . . . .	36
10.1.3	Error message OFL, UFL . . . . .	37
10.2	ORP . . . . .	37
10.2.1	No stable measured value . . . . .	37
10.2.2	Error message OFL, UFL . . . . .	38
10.3	General information . . . . .	38
10.3.1	Symbol for calibration evaluation flashes . . . . .	38
10.3.2	[LoBat] display . . . . .	38
10.3.3	Instrument does not react to keystroke . . . . .	38
10.3.4	Displaying the software version (meter) . . . . .	39
<b>11</b>	<b>Technical data . . . . .</b>	<b>40</b>
11.1	Measuring ranges, resolution, accuracy . . . . .	40
11.1.1	Measuring ranges, resolution . . . . .	40
11.1.2	Manual temperature input . . . . .	40

---

11.1.3	Accuracy ( $\pm 1$ digit) .....	40
11.2	General data .....	41
<b>12</b>	<b>Glossary .....</b>	<b>43</b>
12.1	pH/ORP .....	43
12.2	General information .....	44
<b>13</b>	<b>Index .....</b>	<b>47</b>

# 1 Overview

## 1.1 pH 7110 meter

The pH 7110 compact digital precision meter enables you to perform pH and ORP measurements quickly and reliably.

The pH 7110 provides the maximum degree of operating comfort, reliability and measuring certainty for all applications.

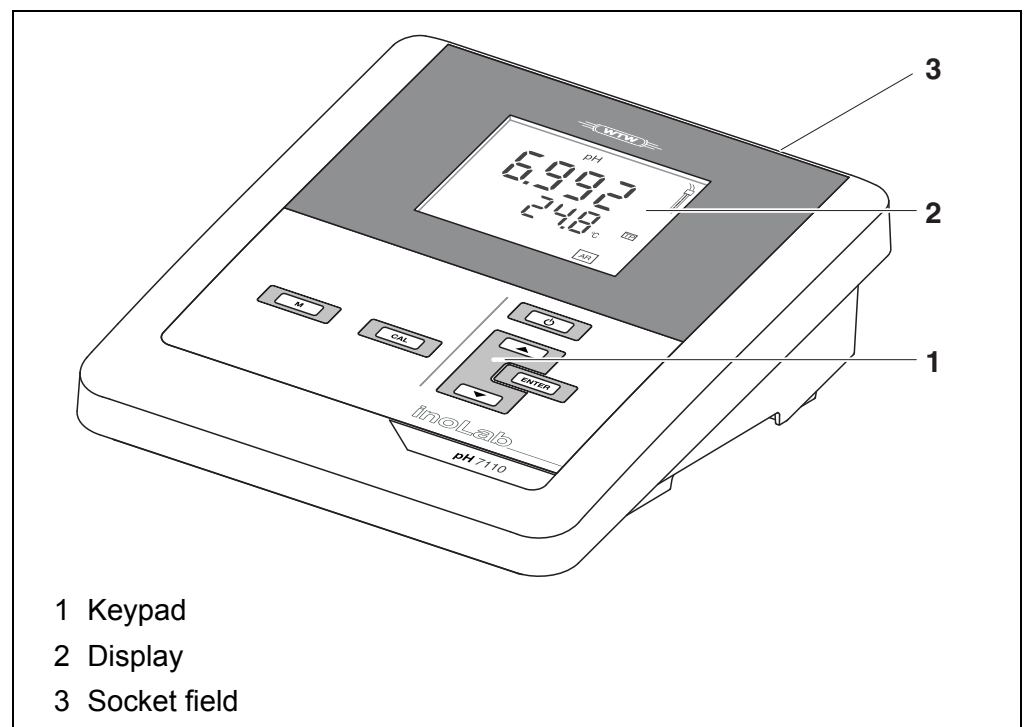

## 1.2 Sensors

A measuring system ready to measure consists of the pH 7110 meter and a suitable sensor.

The pH 7110 can be operated with the following sensors:

- pH electrode
- ORP electrode



Information on available sensors is given on the Internet and in the WTW catalog, "Laboratory and field instrumentation".

## 2 Safety

### 2.1 Safety information

#### 2.1.1 Safety information in the operating manual

This operating manual provides important information on the safe operation of the meter. Read this operating manual thoroughly and make yourself familiar with the meter before putting it into operation or working with it. The operating manual must be kept in the vicinity of the meter so you can always find the information you need.

Important safety instructions are highlighted in this operating manual. They are indicated by the warning symbol (triangle) in the left column. The signal word (e.g. "CAUTION") indicates the level of danger:

**WARNING**

indicates a possibly dangerous situation that can lead to serious (irreversible) injury or death if the safety instruction is not followed.

**CAUTION**

indicates a possibly dangerous situation that can lead to slight (reversible) injury if the safety instruction is not followed.

**NOTE**

indicates a possibly dangerous situation where goods might be damaged if the actions mentioned are not taken.

#### 2.1.2 Safety signs on the meter

Note all labels, information signs and safety symbols on the meter and in the battery compartment. A warning symbol (triangle) without text refers to safety information in this operating manual.

#### 2.1.3 Further documents providing safety information

The following documents provide additional information, which you should observe for your safety when working with the measuring system:

- Operating manuals of sensors and other accessories
- Safety datasheets of calibration or maintenance accessories (such as buffer solutions, electrolyte solutions, etc.)



## **2.2 Safe operation**

### **2.2.1 Authorized use**

This meter is authorized exclusively for pH and ORP measurements in the laboratory.

Only the operation and running of the meter according to the instructions and technical specifications given in this operating manual is authorized (see section 11 TECHNICAL DATA, page 40).

Any other use is considered unauthorized.

### **2.2.2 Requirements for safe operation**

Note the following points for safe operation:

- The meter may only be operated according to the authorized use specified above.
- The meter may only be supplied with power by the energy sources mentioned in this operating manual.
- The meter may only be operated under the environmental conditions mentioned in this operating manual.
- The meter may only be opened if this is explicitly described in this operating manual (example: Inserting the batteries).

### **2.2.3 Unauthorized use**

The meter must not be put into operation if:

- it is visibly damaged (e.g. after being transported)
- it was stored under adverse conditions for a lengthy period of time (storing conditions, see section 11 TECHNICAL DATA, page 40).

## 3 Commissioning

### 3.1 Scope of delivery

- pH 7110 meter
- 4 batteries 1.5 V Mignon type AA
- Power pack
- Stand
- Stand holder
- Short instructions
- Detailed operating manual (4 languages)
- CD-ROM with detailed operating manual

### 3.2 Power supply

The pH 7110 is supplied with power in the following ways:

- Mains operation with the supplied power pack.
- Battery operation (4 x alkaline manganese batteries, type AA)

### 3.3 Initial commissioning

Perform the following activities:

- Insert the supplied batteries
- Connect the power pack (mains operation)
- Mount the stand
- Switch on the meter  
(see section 4.2 SWITCHING ON THE METER, page 15)

#### 3.3.1 Inserting the batteries



You can operate the meter either with normal batteries or with rechargeable batteries (Ni-MH). In order to charge the batteries, an external charging device is required.

1. Open the battery compartment (2) on the underside of the meter.

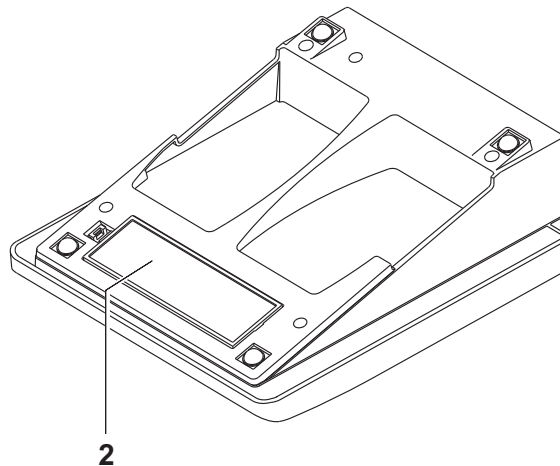

2. Insert four batteries in the battery compartment.

**CAUTION**

Make sure that the poles of the batteries are positioned correctly.

The  $\pm$  signs on the batteries must correspond to the  $\pm$  signs in the battery compartment.

3. Close the battery compartment tightly.



When the batteries are nearly empty, the [LoBat] status indicator is displayed.

### 3.3.2 Connecting the power pack

**CAUTION**

The line voltage at the operating site must lie within the input voltage range of the original power pack (see section 11 TECHNICAL DATA, page 40).

**CAUTION**

Use original power packs only (see section 11 TECHNICAL DATA, page 40).

1. Connect the plug of the power pack to the socket for the power pack on the pH 7110.
2. Connect the original power pack to an easily accessible power outlet.

### 3.3.3 Mounting the stand

The stand base can be mounted at the right side of the meter.

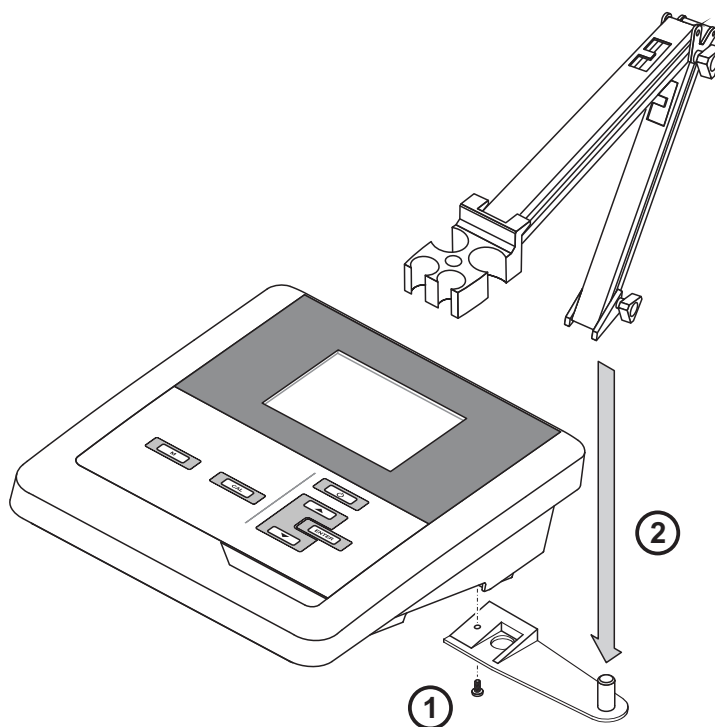

## 4 Operation





### 4.1 General operating principles

This section contains basic information on the operation of the pH 7110.

#### 4.1.1 Keypad

In this operating manual, keys are indicated by brackets <.> .

The key symbol (e.g. <ENTER>) generally indicates a short keystroke (under 2 sec) in this operating manual. A long keystroke (approx. 2 sec) is indicated by the underscore behind the key symbol (e.g. <ENTER\_\_>).

Key	Symbol	Meaning
	<On/Off> <On/Off__>	Switches the meter on or off Resets calibration data
	<M> <M__>	Selects the measured parameter Opens the measurement settings
	<CAL> <CAL__>	Calls up the calibration procedure Displays the calibration data
	<▲><▼> <▲__><▼__>	Increments, decrements values Increments, decrements values continuously
	<ENTER> <ENTER__>	Confirms entries Opens the menu for system settings

### 4.1.2 Display

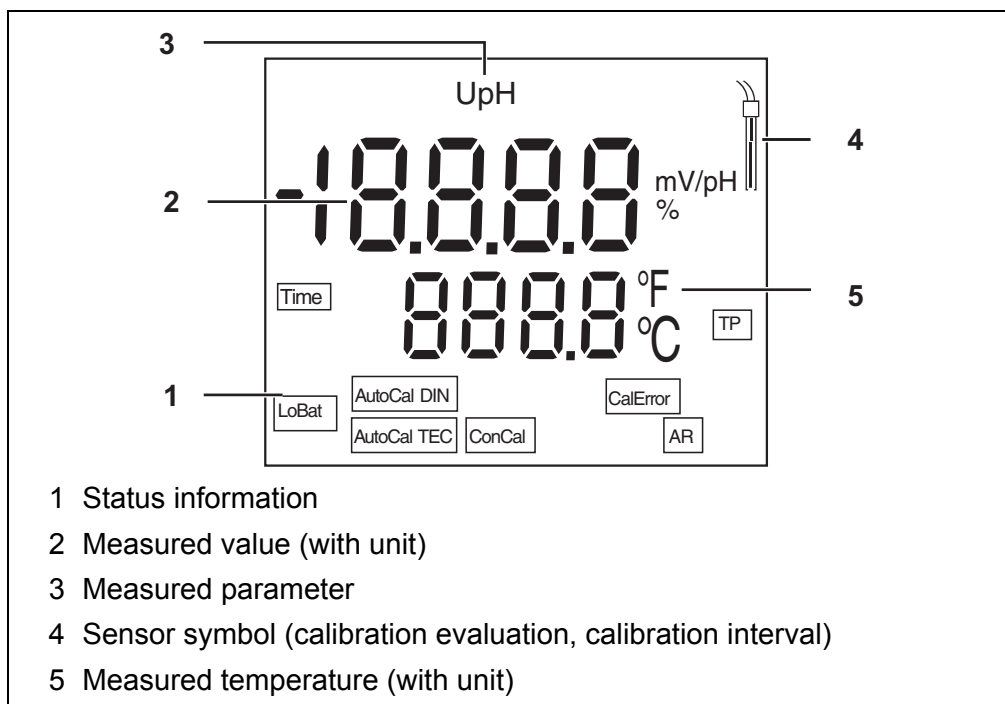

### 4.1.3 Status information

Display	Meaning
[AutoCal TEC] [AutoCal DIN]	Calibration with automatic buffer recognition, e.g. with the buffer set: Technical buffers
[ConCal]	Calibration with any buffers
[CalError]	An error occurred during calibration
[AR]	Stability control (AutoRead) is active
[TP]	Temperature measurement active
[Time]	Setting of calibration interval
[LoBat]	Batteries are almost empty

#### 4.1.4 Socket field

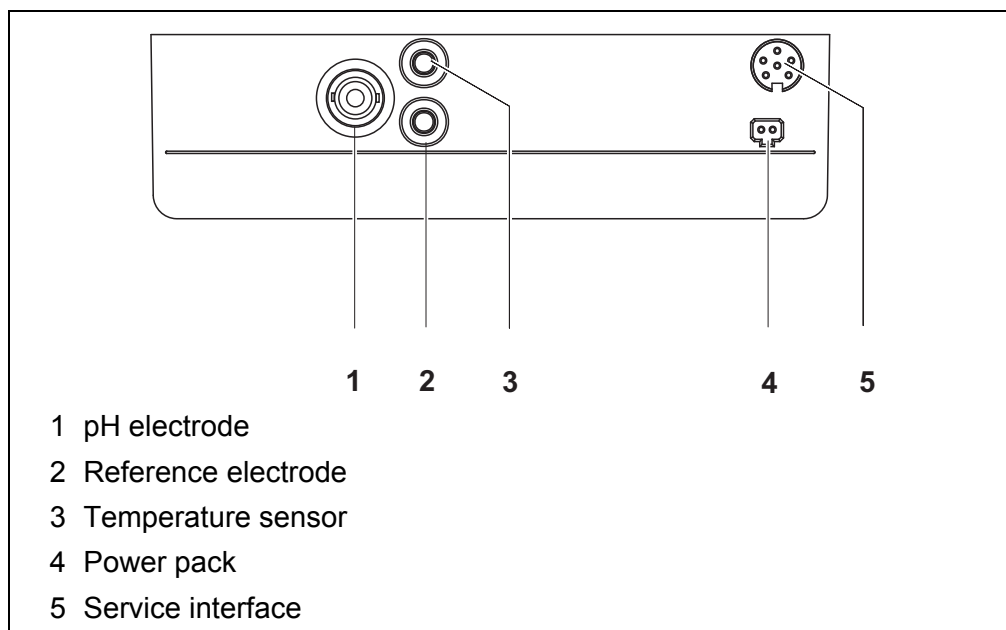

#### 4.2 Switching on the meter

1. Switch on the meter with **<On/Off>**.  
The meter performs a self-test.  
The meter switches to the measuring mode (measured value display).
2. Connect the sensor.  
The meter is ready to measure.

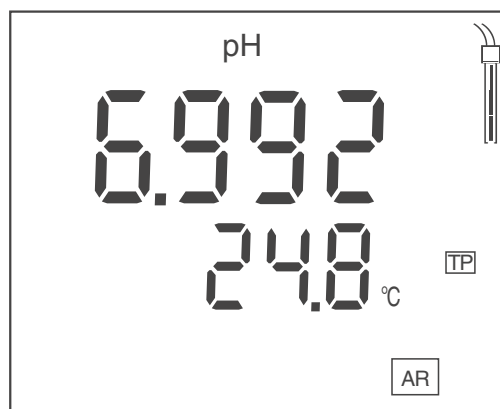

#### 4.3 Switching off the meter

1. Switch off the meter with **<On/Off>**.  
The meter is switched off.



When the meter is powered by the batteries, it switches itself off automatically after an adjustable interval to save the batteries (see section Automatic switch-off function, page 31).

## 4.4 Navigation

### 4.4.1 Operating modes

The meter has the following operating modes:

Operating mode	Description
<b>Measuring</b>	The measurement data of the connected sensor are shown in the measured value display
<b>Calibration</b>	The course of a calibration with calibration information, functions and settings is displayed
<b>Setting</b>	A setting is displayed.

### 4.4.2 Measuring mode (measured value display)

The following functions are available in the measuring mode (measured value display):

- Change the display in the selected measuring window (e. g. pH <-> mV) by pressing **<M>**
- To open the measurement settings, press **<M\_\_>** (long pressure).
- To open the system settings, press **<ENTER\_\_>** (long pressure).

### 4.4.3 Setting mode

The following functions are available in the setting mode:

- To change the current setting, press **<▲><▼>**.
- Confirm the setting with **<ENTER>**.  
The next setting is displayed.  
The settings are stored.



When the last setting is confirmed, the setting menu is automatically quit.

- Press **<M>** to exit the setting mode.



## 5 pH value

### 5.1 Measuring

#### 5.1.1 Measuring the pH value



To ensure the high measurement accuracy of the measuring system, always measure with A current calibration (see section 5.2 CALIBRATION, page 18).

1. Connect the pH electrode to the meter.
2. When measuring without temperature sensor: Temper the test sample or measure the current temperature.
3. If necessary, select the measured parameter (pH) with **<M>**.
4. Immerse the pH electrode in the test sample.  
The measured value is checked for stability (stability control).  
The **[AR]** status display flashes.

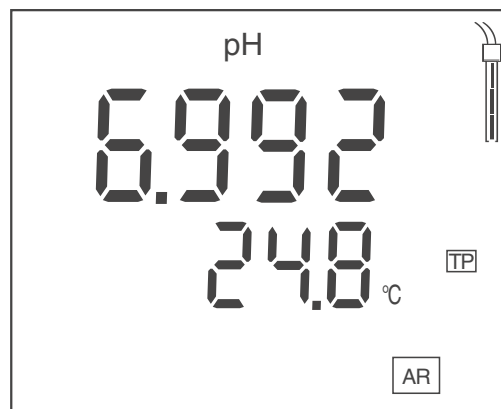

5. When measuring without temperature sensor: Enter the temperature of the test sample with **<▲><▼>**.
6. Wait for a stable measured value.  
The **[AR]** display indicator no longer flashes.

#### Stability control (AutoRead )

During the measuring procedure, the stability control function is automatically activated.

The stability control function (*AutoRead*) continually checks the stability of the measured values in the monitored time interval. The stability has a considerable impact on the reproducibility of measured values. The **[AR]** display indicator flashes until a stable value is measured.

## Stability criteria (AutoRead )

Measured parameter	Time interval	Stability in the time interval
pH value	15 seconds	$\Delta$ : Better than 0.01 pH
Temperature	15 seconds	$\Delta$ : Better than 0.5 °C

The minimum duration until a measured value is assessed as stable is the monitored time interval. The actual duration is mostly longer.

### 5.1.2 Measuring the temperature

For reproducible pH measurements, it is essential to measure the temperature of the test sample.

You have the following options to measure the temperature:

- Automatic measurement of the temperature with the temperature sensor (NTC30 or Pt1000) integrated in the sensor.
- Measurement with an external temperature sensor.
- Manual determination and input of the temperature.

The measuring instrument recognizes whether a suitable sensor is connected and automatically switches on the temperature measurement.

Which type of temperature measurement is active is indicated by the temperature display and the  $[TP]$  status indicator:

Temperature sensor	Resolution of the temp. display	Status indicator	Temp. measurement
yes	0.1 °C	$[TP]$	Automatic with temperature sensor
-	1 °C	-	Manual

If you wish to measure (or calibrate) without temperature sensor, proceed as follows:

1. Measure the current temperature of the test sample.
2. Set the temperature value with  $\langle \blacktriangle \rangle \langle \blacktriangledown \rangle$ .

## 5.2 Calibration

### 5.2.1 Why calibrate?

When a pH electrode is operated, its zero point (asymmetry) and slope change with the course of time. As a result, an inexact measured value is displayed.

Calibration determines and stores the current values of the zero point and slope. Thus, you should calibrate at regular intervals.

### 5.2.2 When to calibrate?

- When the calibration interval has expired
- Routinely within the framework of the company quality assurance
- After connecting another combination electrode

### 5.2.3 Automatic calibration (AutoCal)

Use any one to three buffer solutions of the selected buffer set in ascending or descending order.

Below, calibration with Technical buffers (TEC) is described. When other buffer sets are used, other nominal buffer values are displayed. Apart from that, the procedure is identical.

1. Start the calibration with **<CAL>**.  
The calibration display for the first buffer appears.
2. When measuring without temperature sensor: Temper the buffer or measure the current temperature.
3. If necessary, press **<CAL>** to select the buffer set used (*[AutoCal TEC]*, *[AutoCal DIN]*).  
*Ct1* or *Cd1* is displayed.

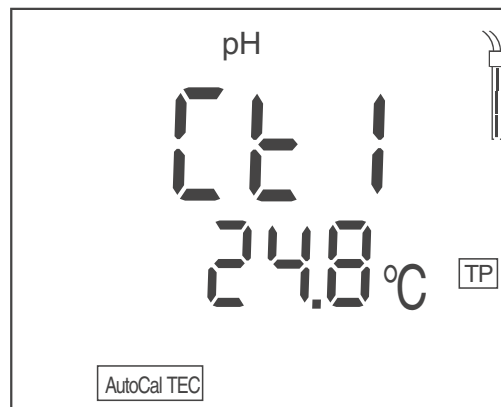

4. Thoroughly rinse the pH electrode with deionized water.
5. Immerse the pH electrode in the first buffer solution.
6. When measuring without temperature sensor: Enter the temperature of the buffer with **<▲><▼>**.
7. Start the measurement with **<ENTER>**.  
The measured value is checked for stability (stability control).  
The *[AR]* status display flashes.  
The electrode voltage (mV) or the nominal value of the buffer is displayed (setting: see section 7.1.1 CHANGING THE SETTINGS FOR PH MEASUREMENTS, page 28).

8. Wait for the measurement with stability control to be completed or terminate the stability control with **<ENTER>**.  
The calibration display for the next buffer appears.  
*Ct2* or *Cd2* is displayed.

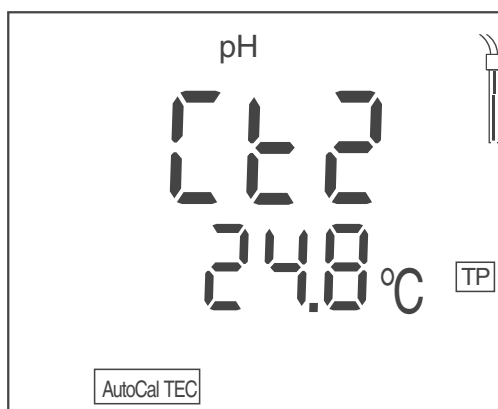

9. If necessary, finish the calibration procedure as a single-point calibration with **<M>**.  
The calibration record is displayed.



For single-point calibration, the instrument uses the Nernst slope ( $-59.2 \text{ mV/pH}$  at  $25 \text{ }^\circ\text{C}$ ) and determines the zero point of the pH electrode.

or

Continue calibration using the next buffer with **<ENTER>**.

#### Continuing with two-point calibration

10. Thoroughly rinse the pH electrode with deionized water.
11. Immerse the pH electrode in the second buffer solution.
12. When measuring without temperature sensor: Enter the temperature of the buffer with **<▲><▼>**.
13. Start the measurement with **<ENTER>**.  
The measured value is checked for stability (stability control).  
The **[AR]** status display flashes.  
The electrode voltage (mV) or the nominal value of the buffer is displayed (setting: see section 7.1.1 CHANGING THE SETTINGS FOR PH MEASUREMENTS, page 28).
14. Wait for the measurement with stability control to be completed or terminate the stability control and take over the calibration value with **<ENTER>**.  
The calibration display for the next buffer appears.  
*Ct3* or *Cd3* is displayed.

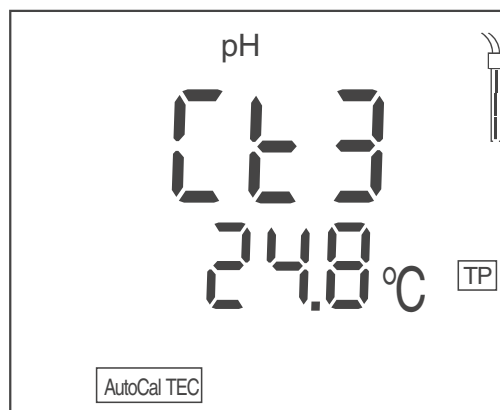

15. If necessary, finish the calibration procedure as a two-point calibration with **<M>**.  
The calibration record is displayed.

**or**

Continue calibration using the next buffer with **<ENTER>**.

#### **Continuing with three-point calibration**

16. Thoroughly rinse the pH electrode with deionized water.
17. Immerse the pH electrode in the third buffer solution.
18. When measuring without temperature sensor: Enter the temperature of the buffer with **<▲><▼>**.
19. Start the measurement with **<ENTER>**.  
The measured value is checked for stability (stability control).  
The **[AR]** status display flashes.  
The electrode voltage (mV) or the nominal value of the buffer (setting: see section 7.1.1 CHANGING THE SETTINGS FOR PH MEASUREMENTS, page 28).
20. Wait for the measurement with stability control to be completed or terminate the stability control and take over the calibration value with **<ENTER>**.  
The calibration record is displayed.

#### **5.2.4 Manual calibration (ConCal)**

Use any buffer solution for the single-point calibration. The calibration will be the more accurate the nearer the pH value of the buffer solution is to that of the test sample.

Use the following buffer solutions for two-point calibration:

- one buffer solution with pH  $7.0 \pm 0.5$
- any other buffer solution

1. Start the calibration with **<CAL>**.  
The calibration display for the first buffer appears.
2. When measuring without temperature sensor: Temper the buffer or measure the current temperature.

- If necessary, press **<CAL>** to select the buffer set (*[ConCal]*).  
ASY is displayed.

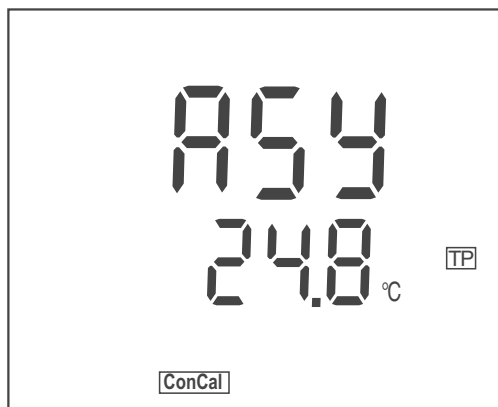

- Thoroughly rinse the pH electrode with deionized water.
- Immerse the pH electrode in the first buffer solution (pH 7.0 ± 0.5 for two-point calibration).
- When measuring without temperature sensor: Enter the temperature of the buffer with **<▲><▼>**.
- Start the measurement with **<ENTER>**.  
The pH value of the buffer solution is displayed.  
The measured value is checked for stability (stability control).  
The *[AR]* status display flashes.
- Wait for the measurement with stability control to be completed.
- Set the nominal pH value of the buffer solution with **<▲><▼>**.
- Accept the calibration value with **<ENTER>**.  
*SLO* is displayed.

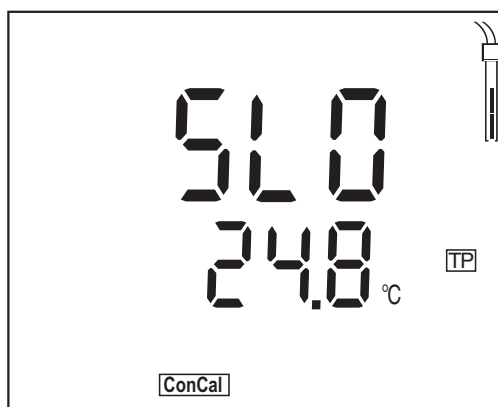

- If necessary, finish the calibration procedure as a single-point calibration with **<M>**.  
The calibration record is displayed.

**or**

Continue calibration using the next buffer with **<ENTER>**.

#### **Continuing with two-point calibration**

- Thoroughly rinse the pH electrode with deionized water.
- Immerse the pH electrode in the second buffer solution.

14. When measuring without temperature sensor: Enter the temperature of the buffer with **<▲><▼>**.
15. Start the measurement with **<ENTER>**.  
The pH value of the buffer solution is displayed.  
The measured value is checked for stability (stability control).  
The **[AR]** status display flashes.
16. Wait for the measurement with stability control to be completed.
17. Set the nominal pH value of the buffer solution with **<▲><▼>**.
18. Accept the calibration value with **<ENTER>**.  
The calibration record is displayed.

### 5.2.5 Calibration points

Depending on the number of buffer solutions used, the meter determines the following values and calculates the calibration line:

Calibration	Values determined	Displayed calibration data
1-point	<i>Asy</i>	<ul style="list-style-type: none"> <li>• Zero point = <i>Asy</i></li> <li>• Slope = Nernst slope (-59.2 mV/pH at 25 °C)</li> </ul>
2-point	<i>Asy</i> <i>Slo</i>	<ul style="list-style-type: none"> <li>• Zero point = <i>Asy</i></li> <li>• Slope = <i>Slo</i></li> </ul> <p>The calibration line goes through both calibration points.</p>
3-point	<i>Asy</i> <i>Slo</i>	<ul style="list-style-type: none"> <li>• Zero point = <i>Asy</i></li> <li>• Slope = <i>Slo</i></li> </ul> <p>The calibration line is calculated by linear regression.</p>



You can display the slope in the units, mV/pH or % (see section 5.2.6 CALIBRATION DATA, page 23).

### 5.2.6 Calibration data

#### Displaying the calibration data

1. Display the calibration data in the measured value display with **<CAL\_\_>**.  
The value for the asymmetry (**ASY**) is displayed.

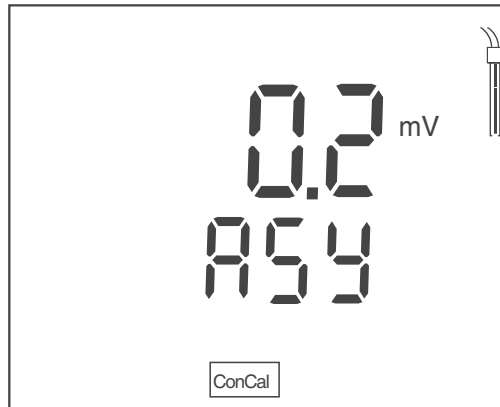

While the zero point is being displayed (ASY) you can switch over the unit of the zero point with  $\langle \blacktriangle \rangle \langle \blacktriangledown \rangle$ .

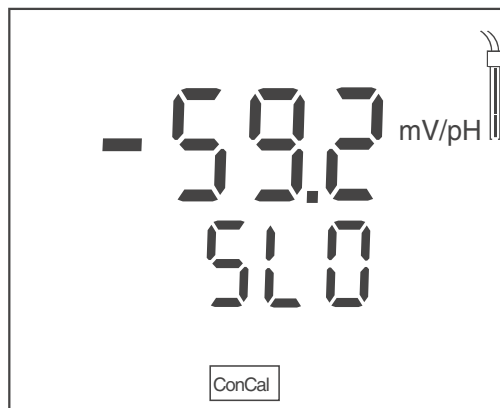

2. Press **<ENTER>** to display further calibration data. The value for the slope (SLO) is displayed.



While the slope is being displayed (SLO) you can switch over the unit of the slope with  $\langle \blacktriangle \rangle \langle \blacktriangledown \rangle$ .

### Calibration evaluation (pH)

After calibrating, the meter automatically evaluates the calibration. The zero point and slope are evaluated separately. The worse evaluation of both is taken into account. The evaluation appears on the display.

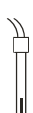
Display	Zero point [mV]	Slope [mV/pH]
	-15 ... +15	-60.5 ... -58.0
	-20 ... <-15 or >+15 ... +20	>-58.0 ... -57.0
	-25 ... <-20 or >+20 ... +25	-61.0 ... <-60.5 or >-57.0 ... -56.0



Display	Zero point [mV]	Slope [mV/pH]
	-30 ... <-25 or ->+25 ... +30	-62.0 ... <-61.0 or >-56.0 ... -50.0
[CalError]	<-30 or >+30	<-62.0 or > -50.0
(see section 10 WHAT TO DO IF..., page 36)		

## 6 ORP

### 6.1 Measuring

#### 6.1.1 Measuring the ORP

1. Connect the ORP electrode to the meter.
2. If necessary, call up the measured parameter U with <M>.
3. Immerse the ORP electrode in the test sample.  
The measured value is checked for stability (stability control).  
The [AR] status display flashes.
4. Wait for a stable measured value.  
The [AR] display indicator no longer flashes.

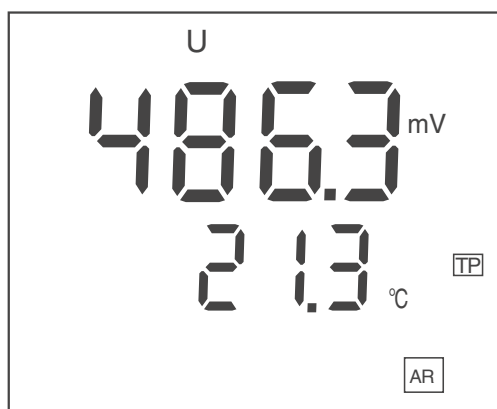

#### Stability control (AutoRead )

During the measuring procedure, the stability control function is automatically activated.

The stability control function (*AutoRead*) continually checks the stability of the measured values in the monitored time interval. The stability has a considerable impact on the reproducibility of measured values. The [AR] display indicator flashes until a stable value is measured.

#### Stability criteria (AutoRead )

Measured parameter	Time interval	Stability in the time interval
ORP	15 seconds	$\Delta$ : Better than 0.3 mV
Temperature	15 seconds	$\Delta$ : Better than 0.5 °C

### 6.1.2 Measuring the temperature

The temperature measurement is absolutely essential for a reproducible ORP measurement.

You have the following options to measure the temperature:

- Measurement with an external temperature sensor.
- Manual determination and input of the temperature.

The measuring instrument recognizes whether a suitable sensor is connected and automatically switches on the temperature measurement.

Which type of temperature measurement is active is indicated by the temperature display and the *[TP]* status indicator:

Temperature sensor	Resolution of the temp. display	Temp. measurement
yes	0.1	Automatic with temperature sensor
-	1 °C	Manual

If the measurement is made without a temperature sensor, proceed as follows:

1. Measure the current temperature of the test sample.
2. Set the temperature value with <▲><▼>.

## 6.2 Calibration

ORP electrodes are not calibrated. You can, however, check ORP electrodes using a test solution.

## 7 Settings

The meter has separate setting routines for the measurement settings and system settings.

### 7.1 Measurement settings (pH)

#### 7.1.1 Changing the settings for pH measurements

1. Open the setting menu in the measured value display with **<M\_\_>**.  
The first setting is displayed.
2. If necessary, indicate the required setting with **<ENTER>**.
3. To change the current setting, press **<▲><▼>**.
4. Confirm the setting with **<ENTER>**.  
The next setting is displayed.
5. Change or confirm the other settings.



When the last setting is confirmed, the setting menu is automatically quit.

or

Quit the setting menu with **<M>**.  
The settings are stored.

#### Settings for pH measurements

Default settings are printed in **bold**.

The settings appear in the following order:

Displayed (Confirm with <b>&lt;ENTER&gt;</b> )	Possible setting (Change with <b>&lt;▲&gt;&lt;▼&gt;</b> )	Description
pH <i>bUFF</i>	<b>pH</b> U	Display during calibration Nominal buffer value (pH) or Electrode voltage (U)
pH <i>SLO</i>	<b>mV/pH</b> %	Unit of the value for the slope
pH <i>ASY</i>	<b>mV</b> pH	Unit of the value for the zero point

Displayed (Confirm with <ENTER>)	Possible setting (Change with <▲><▼>)	Description
pH <i>rES</i>	0.000 0.00 0.0	Resolution of pH display
<i>Unit</i>	°C °F	Temperature unit
<i>Int.C</i>	1 ... 7... 999 d	Calibration interval

### 7.1.2 Buffer sets for calibration

You can use the buffer sets quoted in the table for an automatic calibration. The pH values are valid for the specified temperature values. The temperature dependence of the pH values is taken into account during the calibration.



The buffer set is selected during calibration (see section 5.2.3 AUTOMATIC CALIBRATION (AUTO CAL), page 19).

No.	Buffer set	pH values	at
1	TEC WTW Technical buffers	2,000 4,010 7,000 10,011	25 °C
2	NIST/DIN DIN buffers according to DIN 19266 and NIST Traceable Buffers	1.679 4.006 6.865 9.180 12.454	25 °C
3	ConCal	<b>1-point cal.:</b> • Any <b>2-point cal.:</b> • 7.0 ± 0.5 • Any	any, adjust- able

### 7.1.3 Calibration interval



The calibration interval is set with the measurement settings (see section 7.1 MEASUREMENT SETTINGS (PH), page 28).

The calibration evaluation is displayed as a sensor symbol.

The sensor symbol flashes after the adjusted calibration interval has expired.

It is still possible to measure.



To ensure the high measuring accuracy of the measuring system, calibrate after the calibration interval has expired.

## 7.2 Measurement settings (ORP)

### 7.2.1 Changing the settings for ORP measurements

1. Open the setting menu in the measured value display with **<M\_\_>**.  
The first setting is displayed.
2. Indicate the required setting with **<ENTER>**.
3. To change the current setting, press **<▲><▼>**.
4. Confirm the setting with **<ENTER>**.  
The next setting is displayed.
5. Change or confirm the other settings.



When the last setting is confirmed, the setting menu is automatically quit.

or

Quit the setting menu with **<M>**.  
The settings are stored.

#### List of the settings for ORP measurements

The settings for ORP measurements are in the same setting routine as the settings for pH measurements.

Default settings are printed in **bold**.

Displayed (Confirm with <ENTER>)	Possible setting (Change with <▲><▼>)	Description
<i>U rES</i>	<b>0.0</b> 0	Resolution of the voltage display
<i>Unit</i>	°C °F	Temperature unit

## 7.3 Sensor-independent settings

### 7.3.1 Changing the sensor-independent settings

1. Open the menu for the sensor-independent settings with <ENTER\_\_>. The first setting is displayed.
2. To change the current setting, press <▲><▼>.
3. Confirm the setting with <ENTER>. The settings are finished. The meter switches to the measuring mode.

#### List of sensor-independent settings

Default settings are printed in **bold**.

Displayed (Confirm with <ENTER>)	Possible setting (Change with <▲><▼>)	Description
<i>t.Off</i>	10, 20, 30, 40, 50 min, <b>1</b> , 2, 3, 4, 5, 10, 15, 20, 24 h	Switch-off interval (see section Automatic switch-off function, page 31)

### 7.3.2 Energy saving (battery operation)

#### Automatic switch-off function

The meter has an automatic switch-off function to avoid unnecessary power consumption during battery operation.

The energy saving feature switches off the meter during battery operation if no key is pressed during the adjusted interval.

The automatic switch-off function is not active when the power pack is connected.

The switch-off interval is set with the system settings (see section 7.3 SENSOR-INDEPENDENT SETTINGS, page 31).

## 8 Reset

You can erase the calibration values and reset (initialize) the measurement and system settings.

### 8.1 Resetting the calibration values

1. Press **<On/Off\_\_>** to open the menu for the reset of the calibration data.  
*Init.C* is displayed.
2. Use **<▲><▼>** to display *no* or *YES*.
  - *YES*: Reset the calibration values
  - *no*: Retain the calibration values.
3. Confirm with **<ENTER>**.  
The menu is finished. The meter switches to the measuring mode.



The calibration values are reset to default. All other meter settings are retained.

Recalibrate after performing a reset.

#### Calibration values to be reset

Calibration value	Default settings
Zero point (ASY)	0 mV (pH 7.000)
Slope (SLO)	-59.16 mV/pH (100 %)

### 8.2 Resetting the measurement and system settings

1. Switch on the meter with **<On/Off>**.  
The display test appears briefly on the display.
2. During the display test, press **<M>** to open the menu for the reset of the meter settings.  
*Init* is displayed.
3. Use **<▲><▼>** to display *no* or *YES*.
  - *YES*: Reset the meter settings.
  - *no*: Retain the meter settings.
4. Confirm with **<ENTER>**.  
The settings are reset. The menu is finished.  
The meter switches to the measuring mode.





The following settings are reset to the delivery condition (default):

- Measurement settings
- System settings
- Calibration data

Recalibrate after performing a reset.

### Measurement and system settings that can be reset

Measurement settings	Default
Display during calibration ( <i>bUFF</i> )	pH (nominal buffer value)
Unit of the value for the slope ( <i>SLO</i> )	mV/pH
Unit of the value for the zero point ( <i>ASY</i> )	mV
Measured value resolution (pH <i>rES</i> )	0.000
Measured value resolution (U <i>rES</i> )	0.0
Unit of the measured temperature value ( <i>Unit</i> )	°C
Calibration interval ( <i>Int.C</i> )	7 d

System settings	Default
Switch-off interval ( <i>t.Off</i> )	1 h

## 9 Maintenance, cleaning, disposal

### 9.1 Maintenance

#### 9.1.1 General maintenance activities

The only maintenance activity required is replacing the batteries.



See the relevant operating manuals of the sensors for instructions on maintenance.

#### 9.1.2 Replacing the batteries



You can operate the meter either with normal batteries or with rechargeable batteries (Ni-MH). In order to charge the batteries, an external charging device is required.

1. Open the battery compartment (2) on the underside of the meter.

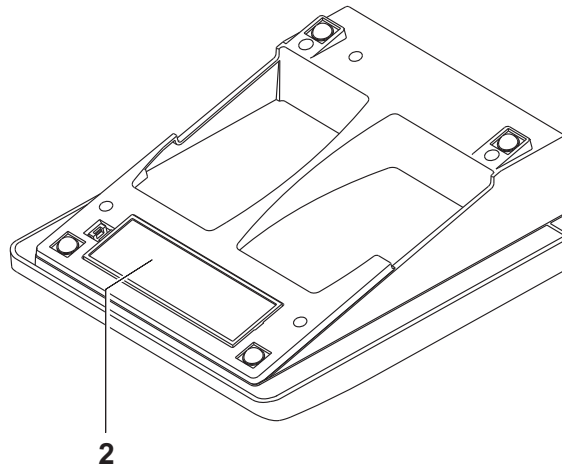

2. Remove the old batteries.
3. Place four batteries (type AA) in the battery compartment.



#### CAUTION

**Make sure that the poles of the batteries are positioned correctly.**

**The  $\pm$  signs on the batteries must correspond to the  $\pm$  signs in the battery compartment.**

4. Close the battery compartment tightly.



When the batteries are nearly empty, the [LoBat] status indicator is displayed.



Dispose of used batteries according to the local regulations of your country.  
End users within the European Union are obligated to return used batteries (even ecologically compatible ones) to a collection point set up for recycling purposes.  
Batteries are marked with the crossed-out waste container symbol. Therefore, they may not be disposed with the domestic waste.

## 9.2 Cleaning

Occasionally wipe the outside of the measuring instrument with a damp, lint-free cloth. Disinfect the housing with isopropanol as required.



### CAUTION

The housing is made of synthetic material (ABS). Thus, avoid contact with acetone or similar detergents that contain solvents. Remove any splashes immediately.

## 9.3 Packing

This meter is sent out in a protective transport packing.

We recommend: Keep the packing material. The original packing protects the meter against damage during transport.

## 9.4 Disposal

At the end of its operational lifetime, the meter must be returned to the disposal or return system statutory in your country. If you have any questions, please contact your supplier.

## 10 What to do if...

### 10.1 pH



More information and instructions on cleaning and exchange of sensors are given in the documentation of your sensor.

#### 10.1.1 No stable measured value

Cause	Remedy
<ul style="list-style-type: none"> <li>• Junction of the electrode contaminated</li> <li>• Glass membrane of the electrode contaminated</li> </ul>	<ul style="list-style-type: none"> <li>• Clean the junction</li> <li>• Clean the glass membrane</li> </ul>

Cause	Remedy
<ul style="list-style-type: none"> <li>• pH value of the test sample not stable</li> <li>• Temperature of the test sample not stable</li> </ul>	<ul style="list-style-type: none"> <li>• Measure with air excluded if necessary</li> <li>• Adjust temperature if necessary</li> </ul>

#### 10.1.2 Error message CalError

Cause	Remedy
<ul style="list-style-type: none"> <li>• The values determined for zero point and slope of the electrode are outside the allowed limits.</li> <li>• Junction contaminated</li> <li>• pH electrode broken</li> </ul>	<ul style="list-style-type: none"> <li>• Recalibrate</li> <li>• Clean the junction</li> <li>• Replace the pH electrode</li> </ul>

Cause	Remedy
<ul style="list-style-type: none"> <li>• The used buffer solutions do not agree with the set buffer set</li> <li>• Buffer solutions too old</li> <li>• Buffer solutions depleted</li> </ul>	<ul style="list-style-type: none"> <li>• Set different buffer set or</li> <li>• Use different buffer solutions</li> <li>• Use only once. Note the shelf life</li> <li>• Change solutions</li> </ul>

### 10.1.3 Error message OFL, UFL

The measured value is outside the measuring range.

The measured value is obviously incorrect.

Cause	Remedy
<ul style="list-style-type: none"> <li>• Cable broken</li> <li>• Gel electrolyte dried out</li> <li>• Air bubble in front of the junction</li> <li>• Air in the junction</li> </ul>	<ul style="list-style-type: none"> <li>• Replace the electrode</li> <li>• Replace the electrode</li> <li>• Remove the air bubble</li> <li>• Extract air or moisten the junction</li> </ul>

## 10.2 ORP



More information and instructions on cleaning and exchange of sensors are given in the documentation of your sensor.

### 10.2.1 No stable measured value

Cause	Remedy
<ul style="list-style-type: none"> <li>• Junction contaminated</li> <li>• Pt-ORP electrode contaminated</li> </ul>	<ul style="list-style-type: none"> <li>• Clean the junction</li> <li>• Clean the Pt-ORP electrode</li> </ul>

Cause	Remedy
<ul style="list-style-type: none"> <li>• ORP value not stable</li> <li>• Temperature not stable</li> </ul>	<ul style="list-style-type: none"> <li>• Measure with air excluded if necessary</li> <li>• Adjust temperature if necessary</li> </ul>

### 10.2.2 Error message OFL, UFL

The measured value is outside the measuring range of the meter.

The measured value is obviously incorrect.

Cause	Remedy
<ul style="list-style-type: none"> <li>• Cable broken</li> <li>• Gel electrolyte dried out</li> <li>• Air bubble in front of the junction</li> <li>• Air in the junction</li> </ul>	<ul style="list-style-type: none"> <li>• Replace the electrode</li> <li>• Replace the electrode</li> <li>• Remove the air bubble</li> <li>• Extract air or moisten the junction</li> </ul>

## 10.3 General information

### 10.3.1 Symbol for calibration evaluation flashes

Cause	Remedy
Calibration interval expired	Recalibrate the measuring system

### 10.3.2 [LoBat] display

Cause	Remedy
Batteries almost empty	Replace the batteries (see section 3.3.1 INSERTING THE BATTERIES, page 10)

### 10.3.3 Instrument does not react to keystroke

Cause	Remedy
Operating condition undefined or EMC load unallowed	<ul style="list-style-type: none"> <li>• Processor reset: Press the &lt;ENTER&gt; and &lt;On/Off&gt; key simultaneously</li> </ul>

### 10.3.4 Displaying the software version (meter)

Cause	Remedy
E. g., a question by the service department	<ul style="list-style-type: none"><li>• Switch on the meter. During the display test, display the software version with <b>&lt;ENTER&gt;</b>.</li></ul>

# 11 Technical data

## 11.1 Measuring ranges, resolution, accuracy

### 11.1.1 Measuring ranges, resolution

Parameter	Measuring range	Resolution
pH	- 2.0 ... + 20.0	0.1
	- 2.00 ... + 20.00	0.01
	- 2.000 ... + 19.999	0.001
U [mV]	- 1200.0 ... + 1200.0	0.1
	- 2000 ... + 2000	1
T [°C]	- 5.0 ... + 105.0	0.1
T [°F]	+ 23.0 ... + 221.0	0.1

### 11.1.2 Manual temperature input

Parameter	Range	Increment
T <sub>manual</sub> [°C]	- 25 ... + 130	1
T <sub>manual</sub> [°F]	-13 ... + 266	1

### 11.1.3 Accuracy (± 1 digit)

Parameter	Accuracy	Temperature of the test sample
pH / range * - 2.0 ... + 20.0 - 2.00 ... + 20.00 - 2.000 ... + 19.999	± 0.1	+ 15 °C ... + 35 °C
	± 0.01	+ 15 °C ... + 35 °C
	± 0.005	+ 15 °C ... + 35 °C
U [mV] / range - 2000 ... + 2000 -1200.0 ... +1200.0	± 1	+ 15 °C ... + 35 °C
	± 0.3	+ 15 °C ... + 35 °C
T [°C] / temperature sensor • NTC 30 • PT 1000	± 0.1 ± 0.1	

\* when measuring in a range of ± 2 pH around a calibration point



## 11.2 General data

<b>Dimensions</b>	Approx. 230 x 190 x 80 mm
<b>Weight</b>	Approx. 1.0 kg
<b>Mechanical structure</b>	Type of protection IP 43
<b>Electrical safety</b>	Protective class III
<b>Test certificates</b>	CE
<b>Ambient conditions</b>	<b>Storing:</b> - 25 °C ... + 65 °C
	<b>Operation:</b> +5 °C ... + 55 °C With the power pack connected: +5 °C ... + 40 °C
	<b>Allowable relative humidity</b> Yearly mean: < 75 % 30 days/year: 95 % Other days: 85 %
<b>Power supply</b>	<b>Batteries:</b> 4 x 1.5 V alkali-manganese batteries, type AA <b>Operating time:</b> Approx. 2500 h (operating hours)
	<b>Rechargeable batteries:</b> 4 x 1.2 V NiMH rechargeable batteries, type AA (no charging function)
	<b>Power pack:</b> Ktec KSAC 0900110W1UV-1 Input: 100 ... 240 V ~ / 50 ... 60 Hz / 270 mA Output: 9 V = / 1.1 A Connection max. Overvoltage category II Primary plugs included in the scope of delivery: Euro, US, UK and Australian.
<b>Sensor input</b>	<b>Input resistance:</b> > 5 * 10 <sup>12</sup> ohm
	<b>Input current:</b> < 1 * 10 <sup>-12</sup> A
<b>Service interface</b>	This interface can be used for service purposes only.

<b>Applicable directives and standards</b>	<b>EMC:</b> <ul style="list-style-type: none"> <li>• EC directive 2004/108/EC</li> <li>• EN 61326-1</li> <li>• EN 61000-3-2</li> <li>• EN 61000-3-3</li> <li>• FCC Class A</li> </ul>
	<b>Instrument safety:</b> <ul style="list-style-type: none"> <li>• EC directive 2006/95/EC</li> <li>• EN 61010-1</li> <li>• UL 61010-1</li> <li>• CAN/CSA-C22.2#61010-1</li> </ul>
	<b>IP type of protection:</b> <ul style="list-style-type: none"> <li>• EN 60529</li> </ul>

**FCC Class A Equipment Statement**

*Note:* This equipment has been tested and found to comply with the limits for a Class A digital device, pursuant to Part 15 of the FCC Rules. These limits are designed to provide reasonable protection against harmful interference when the equipment is operated in a commercial environment. This equipment generates, uses, and can radiate radio frequency energy and, if not installed and used in accordance with the instruction manual, may cause harmful interference to radio communications. Operation of this equipment in a residential area is likely to cause harmful interference in which case the user will be required to correct the interference at his own expense. Changes or modifications not expressly approved by the manufacturer could void the user's authority to operate the equipment.

## 12 Glossary

### 12.1 pH/ORP

Specialist term	Description
Asymmetry	see zero point
Diaphragm	The junction is a porous body in the housing wall of reference electrodes or electrolyte bridges. It arranges the electrical contact between two solutions and makes the electrolyte exchange more difficult. The expression, junction, is also used for ground or junction-less transitions.
Electromotive force of an electrode	The electromotive force $U$ of the combination electrode is the measurable electromotive force of an electrode in a solution. It equals the sum of all the galvanic voltages of the electrode. Its dependency on the pH results in the electrode function, which is characterized by the parameters, slope and zero point.
ORP	The ORP is caused by oxidizing or reducing substances dissolved in water if these substances become effective on an electrode surface (e. g. a gold or platinum surface).
pH value	The pH value is a measure of the acidic or basic effect of an aqueous solution. It corresponds to the negative decadic logarithm of the molal hydrogen ions activity divided by the unit of the molality. The practical pH value is the value of a pH measurement.
Slope	The slope of a linear calibration function.
Zero point	The zero point of a pH combination electrode is the pH value at which the electromotive force of the pH combination electrode at a specified temperature is zero. Normally, this is at 25 °C.

## 12.2 General information

Specialist term	Description
Adjusting	To manipulate a measuring system so that the relevant value (e. g. the displayed value) differs as little as possible from the correct value or a value that is regarded as correct, or that the difference remains within the tolerance.
AutoRange	Name of the automatic selection of the measuring range.
Calibration	Comparing the value from a measuring system (e. g. the displayed value) to the correct value or a value that is regarded as correct. Often, this expression is also used when the measuring system is adjusted at the same time (see adjusting).
Measured parameter	The measured parameter is the physical dimension determined by measuring, e. g. pH, conductivity or D.O. concentration.
Measured value	The measured value is the special value of a measured parameter to be determined. It is given as a combination of the numerical value and unit (e. g. 3 m; 0.5 s; 5.2 A; 373.15 K).
Molality	Molality is the quantity (in Mol) of a dissolved substance in 1000 g solvent.
Potentiometry	Name of a measuring technique. The signal (depending on the measured parameter) of the electrode is the electrical potential. The electrical current remains constant.
Reset	Restoring the original condition of all settings of a measuring system.
Resolution	Smallest difference between two measured values that can be displayed by a meter.
Stability control (AutoRead )	Function to control the measured value stability.

---

Specialist term	Description
Standard solution	The standard solution is a solution where the measured value is known by definition. It is used to calibrate a measuring system.
Temperature function	Name of a mathematical function expressing the temperature behavior of a test sample, a sensor or part of a sensor.
Test sample	Designation of the test sample ready to be measured. Normally, a test sample is made by processing the original sample. The test sample and original sample are identical if the test sample was not processed.



## 13 Index

### A

AR .....	14
AutoCal .....	19
Automatic switch-off function .....	31
AutoRead .....	17, 26

### B

Battery compartment .....	11, 34
Buffer sets (pH) .....	29

### C

Calibration evaluation (pH) .....	24
Calibration interval (pH) .....	30
ConCal .....	21

### D

Default (calibration values) .....	32
Default (measurement settings) .....	33
Default (system settings) .....	33
Display .....	14

### I

Initial commissioning .....	10
Initialize .....	32

### K

Keys .....	13
------------	----

### M

Measured value display .....	16
Measuring (ORP) .....	26
Measuring (pH) .....	17

### R

Reset .....	32
Resolution setting .....	31

### S

Safe operation .....	9
Scope of delivery .....	10
Single-point calibration (pH, AutoCal) .....	20
Slope (pH electrode) .....	18, 23
Slope, pH .....	24
Socket field .....	15

Stability control .....	17, 26
-------------------------	--------

### Z

Zero point (pH electrode) .....	18, 23
Zero point, pH .....	24







# Xylem |'zīləm|

- 1) The tissue in plants that brings water upward from the roots;
- 2) a leading global water technology company.

We're a global team unified in a common purpose: creating advanced technology solutions to the world's water challenges. Developing new technologies that will improve the way water is used, conserved, and re-used in the future is central to our work. Our products and services move, treat, analyze, monitor and return water to the environment, in public utility, industrial, residential and commercial building services settings. Xylem also provides a leading portfolio of smart metering, network technologies and advanced analytics solutions for water, electric and gas utilities. In more than 150 countries, we have strong, long-standing relationships with customers who know us for our powerful combination of leading product brands and applications expertise with a strong focus on developing comprehensive, sustainable solutions.

**For more information on how Xylem can help you, go to [www.xylem.com](http://www.xylem.com).**



## **Service and Returns:**

Xylem Analytics Germany  
Sales GmbH & Co. KG  
WTW  
Am Achalaich 11  
82362 Weilheim  
Germany

Tel.: +49 881 183-325

Fax: +49 881 183-414

E-Mail [wtw.rma@xylem.com](mailto:wtw.rma@xylem.com)

Internet: [www.xylemanalytics.com](http://www.xylemanalytics.com)

**xylem**  
Let's Solve Water

Xylem Analytics Germany GmbH  
Am Achalaich 11  
82362 Weilheim  
Germany

